



samlexpower

**Switch Mode,
Automatic, Lead
Acid Battery
Charger**

**Model:
SEC - 1260A
SEC - 1280A
SEC - 2440A**

**Owner's
Manual**

Please read this
manual before
operating your
charger

CONTENTS

Important safety precautions.....	2
Description.....	3
Features.....	3
Components and accessories.....	4
Specifying lead acid batteries and chargers.....	5
Charging stages.....	11
Cooling.....	14
Protections.....	15
Installation.....	16
Preparing the charger for operation.....	17
Remote Panel	21
Operation.....	22
Troubleshooting.....	25
Internal / external fuse ratings.....	27
Specifications.....	28
Warranty information.....	31

IMPORTANT SAFETY PRECAUTIONS

Hazardous conditions may result if the charger is not installed or operated correctly. Please read the following instructions to prevent personal injury or damage to the charger.

BATTERY RELATED

- To reduce the risk of battery explosion, follow these instructions and those marked on the battery.
- Never smoke or allow an open spark or flame in the vicinity of the battery or the engine.
- Charge only Lead Acid type of batteries (Flooded / Absorbed Glass Mat (AGM) / Gel Cell). Do not charge other type of batteries like Nickel Cadmium (NiCad), Nickel-Metal Hydride (Ni-MH), Dry-Cell etc. Other types of batteries might burst causing personal injury.
- Never charge a frozen battery.
- Working in the vicinity of Lead Acid batteries is dangerous. Batteries generate explosive gases during normal operation. Take necessary safety precautions when installing the charger near a battery or in a battery compartment (Follow safety instructions given by the battery manufacturer).
- Never place the charger directly above or below the battery being charged; gases or fluids from the battery will corrode and damage the charger. Locate the charger as far away from the battery as DC cables permit. Do not install in the same compartment as batteries.

CHARGER RELATED

- Do not operate the charger in a closed-in area or restrict ventilation in any way. Install in a well ventilated, cool, dry place.
- The charger must not be operated in a damp or wet environment. When mounting in a boat, make sure it is not subjected to bilge water splash.
- Do not block the ventilation openings / openings for the cooling fan. There should be at least 6 inches clearance all around the unit.
- Installation and wiring must comply with the local and the national electrical codes. It is recommended that installation and wiring may be done by a certified electrician.
- Wrong installation on a boat may lead to corrosion of the boat. It is recommended that installation on the boat must be carried out by a boat electrician.
- Disconnect the AC input power to the charger before connecting / disconnecting the batteries or other DC loads or when working on the charger.
- Disconnect the AC input power before changing the setting of the Dip Switches.
- The chassis of the charger is connected to the earth ground pin of the power cord plug. Ensure that the earth ground pin of AC receptacle feeding the charger is connected to earth ground.
- Do not use an adapter. If a grounding type of receptacle is not available, do not use this charger until the proper outlet is installed by a qualified electrician.
- Do not operate the charger if the power cord is damaged.

DESCRIPTION

SEC-1260A/SEC-1280A (for 12 V batteries) and SEC-2440A (for 24 V batteries) are high current, 3 Stage Chargers that deliver 60 A, 80 A and 40 A respectively for almost 75% to 80% of the charging cycle ensuring a very fast, safe and complete charging of lead acid batteries. The nomenclature “I Uo U” is a DIN nomenclature and signifies the 3 charging stages – I for constant current Bulk Charge Stage 1, Uo for constant over voltage Absorption / Boost Stage 2 and U for constant voltage Float / Maintenance Stage 3 (under DIN specification, voltage is designated “U” and current is designated “I”. The subscript “o” in “Uo” signifies over voltage).

FEATURES

- Fully automatic – “Connect and Forget” operation.
- Suitable for flooded , AGM or Gel Cell type of lead acid batteries.
- State-of-the-art switched mode technology is used for high efficiency, lightweight and quiet operation.
- User selectable 2 or 3-Stage automatic charging algorithm with timed Boost / Absorption Stage and temperature compensation ensures rapid, safe and full return of capacity.
- Ability to reduce maximum charging current to approximately 1/2 of the rated capacity during “Half Power Mode”. This allows safe charging of lower capacity batteries.
- Includes a Battery Temperature Sensor allowing temperature compensated charging, if required.
- 2 banks of batteries can be charged simultaneously without the use of an external battery isolator. The charging current will be shared between the two banks depending upon the depth of discharge of the connected batteries.
- 3 colour LED indicates charging status.
- Fan cooled - fan on/off based on output current.
- Protections against short circuit, over current, reverse battery connection and over-temperature.
- Can be used as a power supply or as a DC UPS (Uninterruptible Power Supply) when used in conjunction with a battery.
- Optional Remote LED Panel with 10 Metres of wire for remote on / off control and indication of charging status.

COMPONENTS AND ACCESSORIES

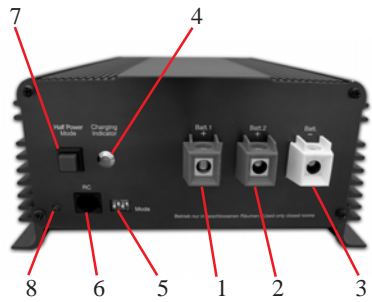

- 1. Output Connector + Bank 1
- 2. Output Connector + Bank 2
- 3. Output Connector - Common
- 4. Charging Indicator LED
- 5. DIP Switches for mode selection
- 6. Jack for Remote Panel
- 7. Push Switch for Half Power Mode
- 8. LED for Half Power Mode indication

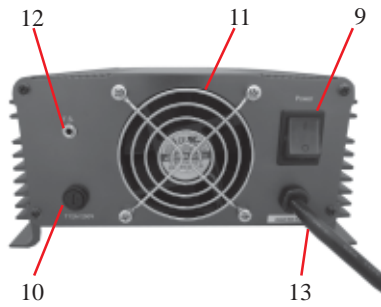

- 9. AC input Power On / Off Switch
- 10. AC fuse holder
- 11. Cooling fan
- 12. Jack for Temperature Sensor
- 13. AC power cord inlet

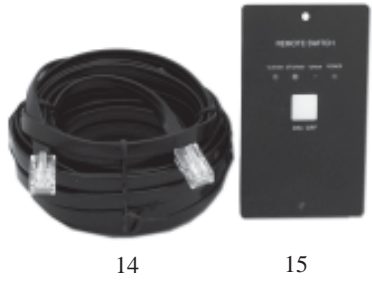

- 14*. Cable with plug
- 15*. Remote Panel
- (*14 & 15 are optional accessories)

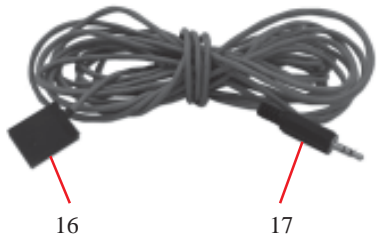

- 16. Temperature sensor element
- 17. Plug

SPECIFYING LEAD ACID BATTERIES AND CHARGERS

FLOODED / WET CELL AND SLA (SEALED LEAD ACID) BATTERIES

There are two categories of lead acid batteries – Flooded/Wet Cell and Sealed Lead Acid (SLA). A flooded/wet cell battery has a high tolerance to overcharging. However, it will release hydrogen gas when charging that must be properly vented and the water level must be checked frequently. SLA batteries can either be Gel Cell or AGM (Absorbed Glass Mat). Both the Gel Cell and AGM are maintenance free, have no liquid to spill and gassing is minimal. The Gel Cell is the least affected by temperature extremes, storage at low state of charge and has a low rate of self discharge. An AGM battery will handle overcharging slightly better than the Gel Cell.

Lead-acid batteries can be categorized by the type of application: **Automotive service - Starting/Lighting/Ignition (SLI, a.k.a. cranking)** and **Deep Cycle service**.

SLI BATTERIES

Everybody is familiar with the SLI batteries that are used for automotive starting and powering vehicular accessories. SLI batteries are designed to produce high power in short bursts but must be constantly recharged (normally with an alternator while driving). Vehicle starting typically discharges 1%-3% of a healthy SLI battery's capacity.

The automotive SLI battery is not designed for repeated deep discharge where up to 80 % of the battery capacity is discharged and then recharged. If an SLI battery is used for this type of application, its useful service life will be drastically reduced.

DEEP CYCLE BATTERIES

Deep cycle batteries are designed with thick-plate electrodes to serve as primary power sources, to have a constant discharge rate, to have the capability to be deeply discharged up to 80 % capacity and to repeatedly accept recharging. They are marketed for use in recreation vehicles (RV), boats and electric golf carts – so they may be referred to as RV batteries, marine batteries or golf cart batteries. There are two categories of deep cycle lead acid batteries – wet and sealed. A wet cell battery has a high tolerance to overcharging. However, it will release hydrogen gas when charging that must be properly vented and the water level must be checked frequently. Sealed batteries can either be Gel Cell or AGM (Absorbed Glass Mat). Both the Gel Cell and AGM are maintenance free, have no liquid to spill and gassing is minimal. The Gel Cell is the least affected by temperature extremes, storage at low state of charge and has a low rate of self discharge. An AGM battery will handle overcharging slightly better than the Gel Cell.

UNITS OF BATTERY CAPACITY

The battery capacity is the measure of the energy the battery can store and deliver to a load. It is determined by how much current any given battery can deliver over a stipulated period of time. The energy rating is expressed in **Ampere Hours (AH)**. For example, as one of the bench marks, the battery industry rates batteries at 20 hour rate i.e. how many Amperes of current the battery can deliver for 20 hours at 80 ° F till the voltage drops to 10.5 Volts for 12 V battery and 21 V for 24 V battery. For example, a 100 AH battery will deliver 5 Amperes for 20 hours. Other bench mark discharge rates are 8-hour rate for UPS batteries & 10-hour rate for telecom batteries. Battery capacity is also expressed as **Reserve Capacity (RC)** in minutes. Reserve capacity is the time in minutes for which the battery can deliver 25 Amperes at 80 ° F till the voltage drops to 10.5 Volts for 12 V battery and 21 V for 24 V battery. Approximate relationship between the two units is as follows:

$$\text{Capacity in AH} = \text{Reserve Capacity in RC minutes} \times 0.6$$

TYPICAL BATTERY SIZES

Below is a chart of some battery sizes applicable for powering inverters:

BCI * Group	Battery Voltage, V	Battery AH
27 / 31	12	105
4 D	12	160
8D	12	225
GC2**	6	220

* Battery Council International

** Golf Cart

REDUCTION IN USABLE CAPACITY AT HIGHER DISCHARGE RATES

As stated above, the rated capacity of the battery in AH is generally applicable at a discharge rate of 20 Hours. As the discharge rate is increased, the usable capacity reduces due to "Peukert Effect". This relationship is not linear but is more or less according to the table below:

Table 1. Battery Capacity versus Rate of Discharge for a 20 Hr Discharge Rate

Hours of Discharge	Usable Capacity
20	100%
10	87%
8	83%
6	75%
5	70%
3	60%
2	50%
1	40%

Using the above table will show that a 100 AH capacity battery will deliver 100% (i.e. full 100 AH) capacity if it is slowly discharged over 20 hours at the rate of 5 Amperes. However, if it is discharged at a rate of 50 Amperes then theoretically, it should provide $100 \text{ AH} \div 50 = 2$ hours. However, the Table above shows that for 2 hours discharge rate, the capacity is reduced to 50% i.e. 50 AH. Therefore, at 50 Ampere discharge rate the battery will actually last for $50 \text{ AH} \div 50 \text{ Amperes} = 1$ Hour.

DEPTH OF DISCHARGE AND BATTERY LIFE

The more deeply a battery is discharged on each cycle, the shorter the battery life. Using more batteries than the minimum required will result in longer life for the battery bank. A typical cycle life chart is given at Table 2 below:

Table 2. – Typical Cycle Life Chart

Depth of Discharge % of AH Capacity	Cycle Life Group 27 / 31	Cycle Life Group 8D	Cycle Life Group GC2
10	1000	1500	3800
50	320	480	1100
80	200	300	675
100	150	225	550

It is recommended that the depth of discharge should be limited to 50 %

LOSS OF BATTERY CAPACITY AT LOW TEMPERATURES

Batteries lose capacity at low temperatures. At 32 ° F, a battery will deliver about 70 to 80 % of its rated capacity at 80 ° F. If the air temperature near the battery bank is lower than 80 ° F, additional batteries will be needed to provide the same usable capacity. For very cold climates, an insulated / heated battery compartment is recommended.

SERIES AND PARALLEL CONNECTION OF BATTERIES

Series Connection

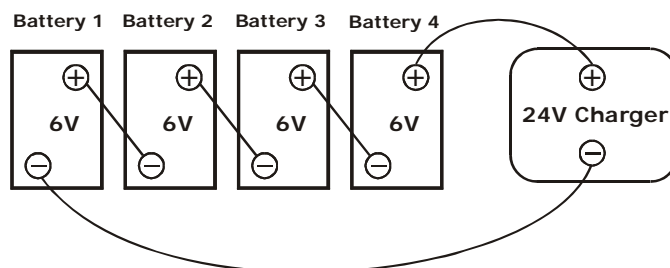

Fig 1. Series Connection

When two or more batteries are connected in series, their voltages add up but their AH capacity remains the same. Fig. 1 above shows 4 pieces of 6 V, 200 AH batteries connected in series to form a battery bank of 24 V with a capacity of 200 AH. The positive terminal of Battery 4 becomes the positive terminal of the 24 V bank. The negative terminal of Battery 4 is connected to the positive terminal of Battery 3. The negative terminal of Battery 3 is connected to the positive terminal of Battery 2. The negative terminal of Battery 2 is connected to the positive terminal of Battery 1. The negative terminal of Battery 1 becomes the negative terminal of the 24 V battery bank.

Parallel Connection

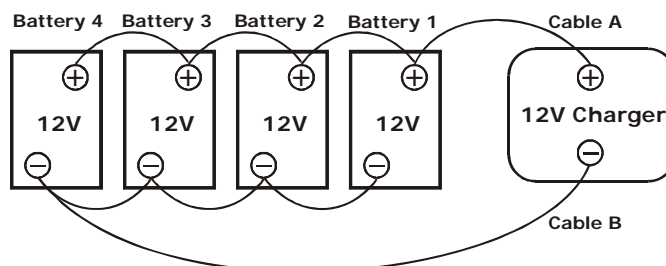

Fig 2. Parallel Connection

When two or more batteries are connected in parallel, their voltage remains the same but their AH capacities add up. Fig. 2 above shows 4 pieces of 12 V, 100 AH batteries connected in parallel to form a battery bank of 12 V with a capacity of 400 AH. The four positive terminals of Batteries 1 to 4 are paralleled (connected together) and this common positive connection becomes the positive terminal of the 12 V bank. Similarly, the four negative terminals of Batteries 1 to 4 are paralleled (connected together) and this common negative connection becomes the negative terminal of the 12 V battery bank.

Series – Parallel Connection

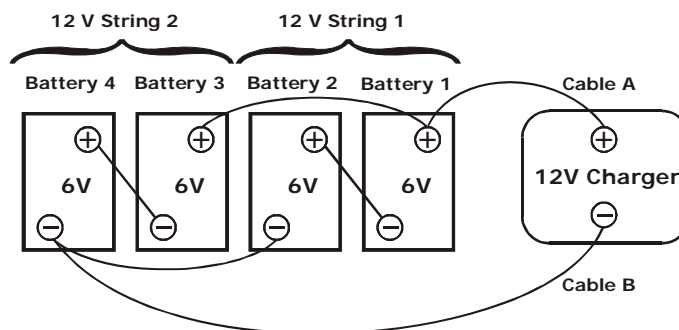

Fig 3. Series-Parallel Connection

Figure 3 above shows a series – parallel connection consisting of four 6V, 200 AH batteries to form a 12 V, 400 AH battery bank. Two 6 V, 200 AH batteries, Batteries 1 and 2 are connected in series to form a 12 V, 200 AH battery (String 1). Similarly, two 6 V, 200 AH batteries, Batteries 3 and 4 are connected in series to form a 12 V, 200 AH battery (String 2). These two 12 V, 200 AH Strings 1 and 2 are connected in parallel to form a 12 V, 400 AH bank.

CAUTION!



When 2 or more batteries / battery strings are connected in parallel and are then connected to a charger (See Figs. 2 and 3 given above), attention should be paid to the manner in which the charger is connected to the battery bank. Please ensure that if the positive output cable of the battery charger (Cable “A”) is connected to the positive battery post of the first battery (Battery 1 in Fig. 2) or to the positive battery post of the first battery string (Battery 1 of String 1 in Fig. 3), then the Negative output cable of the battery charger (Cable “B”) should be connected to the Negative battery post of the last battery (Battery 4 as in Fig. 2) or to the Negative Post of the last battery string (Battery 4 of Battery String 2 as in Fig. 3). This connection ensures the following:

- The resistances of the interconnecting cables will be balanced.
- All the individual batteries / battery strings will see the same series resistance.
- All the individual batteries will charge at the same charging current and thus, will be charged to the same state at the same time.
- None of the batteries will see an overcharge condition.

If the positive output cable of the battery charger (Cable “A”) is connected to the positive battery post of the first battery (Battery 1 in Fig. 2) or to the positive battery post of the first battery string (Battery 1 of String 1 in Fig. 3), and the Negative output cable of the battery charger (Cable “B”) is connected to the Negative battery post of the first battery (Battery 1 as in Fig. 2) or to the Negative Post of the first battery string (Battery 1 of Battery String 1 as in Fig. 3), the following abnormal conditions will result:

- The resistances of the connecting cables will not be balanced.
- The individual batteries will see different series resistances.
- All the individual batteries will be charged at different charging current and thus, will reach fully charged state at different times.
- The battery with lower series resistance will take shorter time to charge as compared to the battery which sees higher series resistance and hence, will experience over charging and its life will be reduced.

Effect of Temperature on Battery Voltage

The chemical reactions inside the battery change with temperature. The cell voltage has a negative temperature coefficient - the cell voltage drops with increase in temperature. Normally, the voltages are specified at 80° F. The charging voltages should be compensated as follows:

12 V battery	- 0.030 V per degree C (-0.017 V per degree F)
24 V battery	- 0.060 V per degree C (-0.033 V per degree F)

CHARGING BATTERIES

The batteries can be charged by using good quality AC powered battery charger or from alternative energy sources like solar panels, wind or hydro systems. Make sure an appropriate battery charge controller is used. It is recommended that the batteries may not be charged at current $> C/5$ (where C is the AH capacity of the battery at 20 hour discharge rate).

Also, for complete charging (return of 100 % capacity), it is recommended that a 3 stage, temperature compensated charger may be used (Constant current bulk charging followed by constant voltage boost / absorption charging followed by constant voltage float charging).

CHARGING STAGES

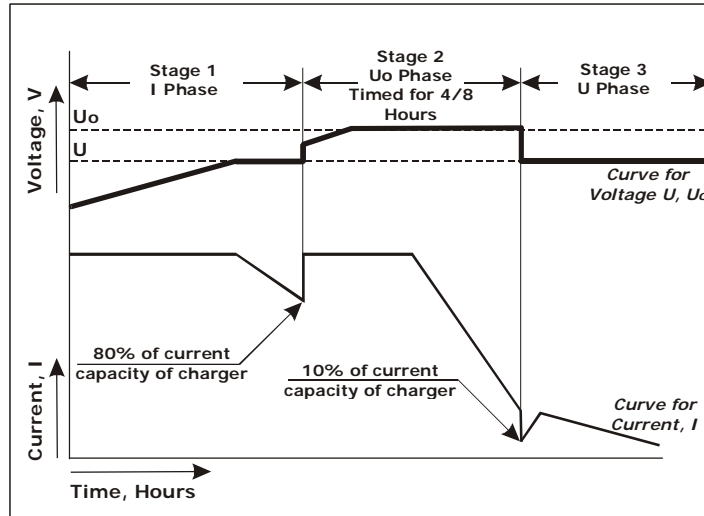

Fig 4. Charging Curve

NOTE: Voltage reading on no load. The output terminals of the charger consist of one common white / black negative terminal (3) and two red positive terminals (1, 2) for charging two banks of batteries. Each of the two positive terminals of the two banks has a Schottky Diode in series for isolation. These isolating diodes have a current dependent forward voltage drop ranging from 0.2 to 0.3 V (at 0.1 A) to 0.6 V (at 40 - 80 A). Please note that the forward voltage drop occurs only when current flows through the diode.

The Float and Absorption voltages are tightly regulated before the isolating diodes. However, the voltages available at the terminals of the two banks will vary with the value of the charging current because of the current dependent forward voltage drop across the isolating diodes. The Float and Boost / Absorption voltages before the diodes are, therefore, set 0.2 to 0.3 V higher to compensate for the above forward drop during float condition when the charging current would have dropped to less than 1 A. Hence, the output voltage at the terminals of the two banks at no load (nothing connected to the terminals of the banks) will read 0.2 to 0.3 V higher because there is no forward voltage drop as there is no current flow through the diodes.

Please also note that the output voltage at the two banks may differ between 0.2 to 0.6 V depending upon the different values of the charging current being delivered through each.

BATTERY VOLTAGES – CHARGED AND DISCHARGED CONDITIONS

The cell voltage of a battery depends upon the temperature of the battery and has a negative temperature coefficient – the voltage level increases at lower temperature and decreases at higher temperature. The voltages are normally specified at 80° F (26.7° C).

On a 12 volt battery, the no load battery voltage is between 11.4 VDC (fully discharged) and 12.9-13.0 VDC (fully charged). On a 24 volt battery, the no load battery voltage is between 22.8 VDC (fully discharged) and 25.8 -26.0 VDC (fully charged).

CHARGING STAGES - I, Uo, U

The charger is preset to charge in 3 stages as described in the succeeding paragraphs. The charger is called “IUoU Charger” based on the DIN designation of the charging stages – “I” Phase, “Uo” Phase and “U” Phase. Please refer to the charging curve given at Figure 4 for understanding the 3 charging stages.

NOTE: The charging voltages indicated below pertain to battery temperature of 80° F.

Stage 1 - Constant Current, Bulk Charge Mode (I Phase): When the charger is first connected to a battery, the battery will start drawing current proportional to the discharged condition of the battery. When the battery is deeply discharged, it will initially try to draw a very large current. If this initial current draw is more than 60 A (SEC-1260A) or more than 80 A (SEC-1280A) or more than 40A (SEC-2440A), the charger will enter Stage 1 – The Bulk Charge Mode (“I” Phase). During this period, SEC-1260A will deliver a constant current “I” = 60 A, SEC-1280A will deliver a constant current “I” = 80 A and SEC-2440A will deliver a constant current “I” = 40 A. The charger will be operating under current limit condition and the voltage at the charging terminal will be same as the actual voltage of the discharged battery. The voltage of the battery will slowly start rising and when the battery voltage approaches voltage U = 13.8 V (SEC-1260A and SEC-1280A) or voltage U = 27.6 V (SEC-2440A), the current drawn by the battery will reduce below the current limit value of 60 A (SEC-1260A), 80 A (SEC-1280A) and 40 A (SEC-2440A). The charger will exit current limit condition and will now output constant voltage of U = 13.8 V (SEC-1260A and SEC-1280A) or constant voltage U = 27.6 V (SEC-2440A). The battery will continue to charge at this constant voltage and its charging current draw will reduce further. When the charging current drawn by the battery reduces below 80% of the charger capacity “I” i.e. 48 A (for SEC-1260A) or 64 A (for SEC-1280A) or 32 A (for SEC-2440A), the charger will automatically switch over to Stage 2 – Constant Over-voltage, Timed Absorption / Boost Charge Stage (“Uo” Phase).

During this Stage, following LED indications are provided:

- Charging Indicator LED (4) on the front panel turns red
- Red LED under “I Phase” is lighted on the Remote Panel (15) (Optional accessory)

NOTE: When “Half Power Mode” is selected (See under “Half Power Mode / Reduction of Maximum Charging Capacity”), the maximum charging capacity (current limit value) of the charger is reduced as follows:

- Current limit of SEC-1260A is reduced to 30 A +/- 1 A instead of 60 A
- Current limit of SEC-1280A is reduced to 40 A +/- 1 A instead of 80 A
- Current limit of SEC-2440A is reduced to 20 A +/- 1 A instead of 40 A

Stage 2 - Constant Overcharge Voltage, Timed Absorption / Boost Charge Mode (Uo Phase): When the charger enters Stage 2 from Stage 1, the battery is approximately 70% to 80% recharged. As soon as it enters this stage, a timer circuit is also initiated. The timer circuit can be selected to operate for 4 or 8 hours with the help of DIP Switches (5) (See under “Selecting time for Absorption / Boost Stage”). During this stage, the charger will output a higher constant overcharge voltage whose value will depend upon the type of battery or charging stages selected (The type of battery and charging stages are selected with the help of DIP Switches (5) – See under “Selecting The Type of Battery and Charging Stages”):

- 14.4 V (SEC-1260A and SEC-1280A) or 28.8 V (SEC-2440A) when Flooded / AGM battery is selected
- 14 V (SEC-1260A and SEC-1280A) or 28 V (SEC-2440A) when Gel Cell battery is selected
- 13.5 V (SEC-1260A and SEC-1280A) or 27 V (SEC-2440A) when loaded battery is selected (2 stage charging)

The battery will further absorb charge at this voltage and the charging current will further reduce. When the charging current reduces to approximately 10% of the charger capacity “I” (6 A +/- 0.5 A for SEC-1260A, 8 A +/- 0.5 A for SEC-1280A and 4 A +/- 0.5 A for SEC-2440A), the charger automatically changes over to “Stage 3 - Float / Maintenance Charge Mode (U Phase)”. However, if the charging current does not reduce to the above threshold level (because of some defective / shorted cells or due to an external load in a loaded battery), the charger will be forced to change-over to “Stage 3 or Float / Maintenance Charge Mode (U Phase)” after elapse of 4 or 8 hours determined by the selected duration of the timer circuit. The battery will be charged to approx. 95% of its capacity by the end of this stage. Ideally it would be at 100%, but there are some practical limitations like temperature effect etc that usually prevent full recharge.

During this Stage, following LED indications are provided:

- Charging Indicator LED (4) on the front panel turns orange
- Yellow LED under “Uo Phase” is lighted on the Remote Panel (15) (Optional accessory)

NOTE: The threshold of current for change-over between the Absorbtion / Boost Charge Mode (“Uo” Phase) & the Float / Maintenance Charge Mode (“U” Phase) are different as follows:

	<u>SEC-1260A</u>	<u>SEC-1280A</u>	<u>SEC-2440A</u>
• From “Uo” Phase to “U” Phase	6 A +/- 0.5 A	8 A +/- 0.5 A	4 A +/- 0.5 A
• From “U” Phase to “Uo” Phase	8.5 A +/- 1 A	10 A +/- 1 A	5 A +/- 0.5 A

Stage 3 – Constant Voltage, Float or Maintenance Charge Mode (U Phase): During this mode, the charger outputs a constant voltage U = 13.5 V (SEC-1260A and SEC-1280A) or 27 V (SEC-2440A). This helps in maintaining full capacity of the battery and also provides replacement charge to overcome self discharge of the battery. The battery can remain connected in this stage indefinitely without the risk of discharging.

During this Stage, following LED indications are provided:

- Charging Indicator LED (4) on the front panel turns green
- Green LED under “U Phase” is lighted on the Remote Panel (15) (Optional accessory)

CAUTION!

3 stage charging is recommended for charging stand-alone unloaded batteries (there is no load connected to the battery when it is being charged). If a load is also connected simultaneously, a part of the charger’s output current will be diverted to this load. Thus, the charger may remain locked in Stage 2 if the current drawn by the load is more than the preset value of threshold current determining change over from Stage 2 to Stage 3 .This will lead to over-charging and loss of electrolyte.

For charging a battery when a load is also connected simultaneously, Stage 2 voltage should be same as Stage 3. Select “Loaded Battery” with the help of DIP Switches (5) – See under “Selecting the Type of Battery and Charging Stages”.

COOLING

The charger is cooled by convection and in addition, has a fan (11) for forced air cooling. The fan will automatically switch on when the charger enters the Boost / Absorption Stage 2 (Charging Indicator LED (4) will be Orange) or the Bulk Charging Stage 1 (Charging Indicator LED (4) will be Red). The fan will automatically stop when the charger enters Float Stage 3 (Charging Indicator LED will be Green). Please note that the fan will be off in the Float Stage 3 (The Charging Indicator LED will be Green).

The operation of the fan is controlled by the current supplied by the charger as follows:

	<u>SEC-1260A</u>	<u>SEC-1280A</u>	<u>SEC-2440A</u>
Switches on when change over from Float stage (“U” Phase) to Boost stage (“Uo” Phase)	8.5 A +/- 1 A	10 A +/- 1 A	5 A +/- 0.5 A
Switches off when change over from Boost stage (“Uo” Phase) to Float stage (“U” Phase)	6 A +/- 0.5 A	8 A +/- 0.5 A	4 A +/- 0.5 A

In case the fan fails or if the cooling is not adequate due to higher ambient temperature, inadequate air circulation or blockage of air ventilation openings, the thermal sensor for over-temperature protection will shut down the output voltage of the charger. The Charging Indication LED on the front panel will turn red (On the Remote Panel, the red LED “I Phase” will light, the green LED “Power” will, however, remain lighted). The charger will be latched in this shut down condition and will **not** reset automatically even after the unit has cooled down. To reset, the AC input power on / off switch (9) at the back of the unit has to be switched off and on again.

PROTECTIONS

The charger has the following protections:

SHORT CIRCUIT SHUT DOWN

In case of a short circuit on the output side, the output of the charger will be shut down. The Charging Indication LED (4) on the front panel will turn red (On the Remote Panel (15), the red LED “I Phase” will light, the green LED “Power” will, however, remain lighted). The charger will be latched in this shut down condition and will **NOT** recover automatically even after the short circuit condition is removed. To reset, the AC input power on / off switch (9) at the back of the unit has to be switched off and on again.

OVER LOAD CURRENT LIMITING

The current drawn by the load is automatically limited to a maximum of 60 A for SEC-1260A (30 A +/- 1 A in “Half Power Mode”), 80 A for SEC-1280A (40 A +/- 1 A in “Half Power Mode”) and 40 A for SEC-2440A (20 A +/- 1 A when in “Half Power Mode”). If the load tries to draw a higher current than these limits, the output voltage of the unit will start to drop. The unit will automatically recover when the overload condition is removed.

REVERSE BATTERY CONNECTION CUT OFF

The output is internally fused on the DC side – 2 x 35 A fuses for SEC-1260A, 3 x 30 A fuses for SEC-1280A and 3 X 15 A fuses for SEC-2440A. In case, the polarity of the battery connection is reversed, the fuse(s) will blow. The Charging Indication LED (4) on the front panel will turn red (On the Remote Panel (15), the red LED “I Phase” will light, the green LED “Power” will, however, remain lighted). The fuse(s) will be required to be replaced for the unit to function again.

THERMAL OVERLOAD SHUTDOWN

CAUTION! Keep the charger in a well ventilated, cool and open area. Do not block the vent holes on the sides or the discharge openings of the cooling fan. In case the fan fails or if the cooling is not adequate due to higher ambient temperature, inadequate air circulation or blockage of air ventilation openings, the thermal sensor for over-temperature protection will shut down the output voltage of the charger. The Charging Indication LED (4) on the front panel will turn red (On the Remote Panel (15), the red LED “I Phase” will light, the green LED “Power” will, however, remain lighted). The charger will be latched in this shut down condition and will **NOT** reset automatically even after the unit has cooled down. To reset, the AC input power on / off (9) switch at the back of the unit has to be switched off and on again.

PROTECTION AGAINST TRANSIENTS / SURGES IN THE AC INPUT

In a number of locations, the AC line input is not clean and may contain high voltage transients / surges. To prevent damage to the internal components against these unwanted high voltages, the charger uses a MOV (Metal Oxide Varistor) for protection. If surge / transient voltage higher than approximately 170 VAC (for 120 VAC input) or 270 VAC (for 230 VAC input) appear in the AC input, the MOV will conduct and will blow the AC side fuse.

INSTALLATION

LOCATION, MOUNTING AND SAFETY

The charger is required to be installed in a safe, well ventilated and dry location. Please see the details given under “Important Safety Precautions”.

The charger can be mounted horizontally or vertically. When mounting vertically, please ensure that the axis of the fan rotor is horizontal (to reduce stress on the bearing).

OUTPUT CONNECTORS

Connectors with tubular, screw down type of terminals are used for output connection. The diameter of the tubular hole of the connector is 8 mm (0.31 inches).

Two positive output connectors (1, 2) are provided for connecting to the positive terminals of the 2 banks of batteries. One common connector (3) is provided for the negative connection.

TERMINAL LUGS FOR CONNECTION TO THE CHARGER

For firm connection when using stranded cable, crimp / solder “pin” style terminal lugs on the charger end of the DC cables used for connecting to the battery / other DC loads. 3 pieces of “pin” style terminal lugs have been provided as follows:

- For SEC-1260A Will accommodate up to AWG # 2 cable
- For SEC-1280A Will accommodate up to AWG # 2 cable
- For SEC-2440A Will accommodate up to AWG # 4 cable

CABLES

To avoid polarity errors and possible damage, never use cables of only one color. Use red insulated cable(s) for positive connection(s) and black for negative connection(s).

Recommended DC cable sizes are given below (Based on a voltage drop of 2%). The length in feet is the length of the pair of the positive and negative DC cables from the charger to the battery / other DC loads.

Distance from battery	SEC-1260A	SEC-1280A	SEC-2440A
Up to 6 ft.	AWG # 4	AWG # 2	AWG # 8
6 to 10 ft	AWG # 2	AWG # 1/0	AWG # 6
10 to 20 ft.	AWG # 2/0	AWG # 3/0	AWG # 4

PREPARING THE CHARGER FOR OPERATION

SELECTING AC INPUT VOLTAGE

The charger is pre-set to operate from AC input voltage of 120 VAC, 50 / 60 Hz.

To operate the charger from AC input voltage of 230 VAC, 50 / 60 Hz, change the internal setting as follows:

1. Remove the bottom cover plate by removing the 4 screws. Please note that the bottom cover plate has 4 rows of ventilation slots towards one end of the plate and this end with the slots is placed towards the end of the housing with the output terminals.

WHEN THE BOTTOM COVER PLATE IS FITTED BACK, ENSURE THAT THIS END OF THE PLATE THAT HAS THE SLOTS IS TOWARDS THE TERMINAL SIDE OF THE HOUSING AND NOT TOWARDS THE OTHER SIDE OF THE HOUSING THAT HAS THE FAN (THIS IS NECESSARY TO CREATE PROPER AIRFLOW PATH BY THE SUCTION CREATED BY THE FAN).

2. Locate the yellow colored loop of wire with black colored, female quick disconnect terminal lugs (here-in after called the "Shorting Link"). This is located towards the fan side and near the two input filter capacitors and the bridge rectifier with the heat sink. In the pre-set condition for 120 VAC operation, this Shorting Link shorts the two vertical pins located at points marked "C" and "D" on the circuit board. For 230 VAC operation, remove the Shorting Link by pulling the black quick disconnect lugs upward. Store this Shorting Link for conversion back to 120 VAC operation, when required. Alternatively, disconnect any one end of the Shorting Link by pulling the black terminal lug upwards. Tape the disconnected end with insulation tape.

3. Replace the AC plug of the power cord with a suitable 3 pin grounded plug to mate with the 230 VAC outlet.

CAUTION! The new plug should have 3 poles i.e. Line (L) , Neutral (N) and Earth ground. Color code for the power cord conductors is : Line (L) - Black , Neutral (N) - White and Earth Ground - Green).

CONNECTING THE BATTERIES OR OTHER DC LOADS

The output of the charger has a common Negative (-) connector (3) and 2 Positive connectors (1, 2) for connection of 2 banks of batteries. Each Positive connector has its own internal isolating diode which works as a battery isolator. If more than one bank of batteries is connected, these will be charged at the same time as long as the AC power is available to the charger (the maximum charging current of 60 A of SEC-1260A, 80 A of SEC-1280A and 40 A of SEC-2440A will be shared among the connected banks of the batteries depending upon their discharged states). In case the AC power fails or if there is no output from the charger, the isolating diodes will prevent charging / discharging among the batteries connected to the banks.

CAUTION! When a single bank consisting of more than one battery in parallel is to be charged, make sure that their negatives are connected to the common negative connector (3) of the charger and their positives are connected to the same positive connector (either 1 or 2) of the charger. For example, when charging a bank consisting of 3 batteries connected in parallel, their 3 negative terminals should be connected to the common negative terminal (3) of the charger and all their 3 positive terminals should be connected to the same positive terminal of the charger (either 1 or 2). Alternatively, the negative terminals of the 3 batteries should first be shorted and then connected to the common negative terminal (3) of the charger and similarly, the 3 positive terminals of the battery should first be shorted and then connected to one of the 2 positive terminals of the charger (either 1 or 2).

When connecting a single battery or other DC load, it can be connected to the common negative (3) and any one of the 2 positive terminals (either 1 or 2)

CHARGING MORE THAN ONE BANK OF BATTERIES

CAUTION! When charging more than one bank of batteries at the same time using 3 Stage Charging, ensure that the batteries in the banks are in a similar discharged condition. If one bank is completely discharged and another is almost fully charged, the bank that is fully charged will be subjected to over charge condition during the time when the charger remains in Stage 2 (“Uo” Phase) for charging the completely discharged bank.

If 2 banks of batteries are required to be charged and they are at different discharged conditions, select “Loaded Battery” (2 Stage Charging) with the help of switches S1 and S2 of the set of 4 DIP Switches (5) (both S1 & S2 in off condition) – See under “Selecting the Type of Battery and Charging Stages”.

SELECTING THE TYPE OF BATTERY AND CHARGING STAGES

The Float or Maintenance Charge Mode (“U” Phase) voltage and Absorption / Boost Charge Mode (“Uo” Phase) voltage of different types of Lead Acid Batteries are different. 3 Stage charging (Stages 1, 2 and 3) is recommended when charging stand alone, unloaded battery (The battery has no load connected to it when it is being charged).

When the charger is used to charge a battery and simultaneously supply an external load, the voltage level of Stage 2 is required to be set to the same level as the voltage of Stage 3 to prevent over-charging. Effectively, the battery will be charged in 2 stages only – Stage 1 and Stage 3. This also applies when two banks of batteries are being charged simultaneously and the batteries in the two banks are in a dissimilar state of discharge.

A pair of switches S1 & S2 out of a set of 4 DIP Switches (5) has been provided for selecting the battery type and for modifying the Boost Stage when charging loaded batteries / two banks of batteries with different discharged states. The following selections can be made with the help of the DIP Switches S1 and S2:

CAUTION! Do not change the DIP Switch setting when the charger is operating. Always change the DIP Switch setting when the charger is off, i.e. after disconnecting the charger from the AC input power).

NOTE: The voltages are for battery temperature of 80° F.

DIP Switch Setting for SEC-1260A & SEC-1280A

S1	S2	Float	Boost	Battery Type / Application	Charging Stages
<u>Stand-alone charging</u>					
OFF *	ON *	13.5 V *	14.4 V *	Flooded / AGM *	3 Stages (Stages 1, 2, 3)
ON	OFF	13.5 V	14.0 V	Gel Cell	3 Stages (Stages 1, 2, 3)
<u>Charging loaded battery</u>					
or					
<u>Charging two banks and the batteries in the two banks are in dissimilar discharged condition</u>					
OFF	OFF	13.5 V	13.5 V	Loaded Battery (can be Flooded / AGM / Gel Cell)	2 Stages (Stages 1, 3)

* Factory preset in this position

DIP Switch Setting for SEC-2440A

S1	S2	Float	Boost	Battery Type / Application	Charging Stages
<u>Stand-alone charging</u>					
OFF *	ON *	27 V *	28.8 V *	Flooded / AGM *	3 Stages (Stages 1, 2, 3)
ON	OFF	27 V	28.0 V	Gel Cell	3 Stages (Stages 1, 2, 3)

Charging loaded battery

or

Charging two banks and the batteries in the two banks are in dissimilar discharged condition

OFF	OFF	27 V	27.0 V	Loaded Battery (can be Flooded / AGM / Gel Cell)	2 Stages (Stages 1, 3)
-----	-----	------	--------	---	------------------------

* Factory preset in this position

CAUTION!

Please ensure that position S1- ON and S2 – ON is never selected

SELECTING THE TIME FOR STAGE 2 - CONSTANT OVERCHARGE VOLTAGE, TIMED ABSORPTION / BOOST CHARGE MODE (“Uo” PHASE)

Stage 2 - Constant Overcharge Voltage, Timed Absorption / Boost Charge Mode (“Uo” Phase) is controlled by an internal timer circuit. Time of 4 hours or 8 hours can be selected with the help of a pair of switches S3 & S4 of the set of 4 DIP Switches (5). Select the times as follows:

<u>Time</u>	<u>DIP Switch S3</u>	<u>DIP Switch S4</u>	<u>Type of Battery</u>
4 hours*	Off*	On*	Flooded / wet cell
8 hours	On	Off	Gel Cell & AGM
Disable	Off	Off	-

* Factory preset in this position

CAUTION!

Please ensure that position S3- ON and S4 – ON is never selected

REDUCTION OF MAXIMUM CHARGING CAPACITY TO HALF TO CHARGE LOWER CAPACITY BATTERIES

Batteries should not be charged at very high currents to ensure long life. Normally, the maximum charging current should be limited to approximately C/5 (where C is the AH capacity of the battery at 20 hour rate). Thus, at the rated current capacities (60 A for SEC-1260A, 80 A for SEC-1280A and 40 A for SEC-2440A), the minimum AH capacity of the battery that should be charged with the charger will be:

- 60 A x 5 = 300 AH for SEC-1260A
- 80 A x 5 = 400 AH for SEC-1280A
- 40 A x 5 = 200 AH for SEC-2440A

Thus, SEC-1260A should be used to charge battery with AH capacity > 300 AH, SEC-1280A should be used to charge battery with AH capacity > 400 AH and SEC-2440A should be used to charge battery with AH capacity > 200 AH.

A provision has been made to reduce the maximum charging current to approximately half: 30 A +/- 1 A for SEC-1260A, 40 A +/- 1 A for SEC-1280A & 20 A +/- 1 A for SEC-2440A. This mode is termed as "Half Power Mode". This mode can be selected by pressing push switch (7) marked "Half Power Mode". When selected, a Green LED (8) marked "Half Power" will be lighted. When "Half Power Mode" is selected, batteries with the following minimum capacities can be charged:

- SEC-1260A - 150 AH and above
- SEC-1280A - 200 AH and above
- SEC-2440A - 100 AH and above

TEMPERATURE COMPENSATION

The cell voltages of a battery depend upon the temperature of the cells inside the battery. The cells have a negative temperature coefficient – their voltage levels increase at lower temperature and decrease at higher temperature. The negative temperature coefficient is – 2.8 mV / ° F / cell or - 16.8 mV / ° F / 6 cells for a 12 V battery or - 33.6 mV / ° F / 12 cells for a 24 V battery.

The battery and battery charger voltages are normally specified at a temperature of 80 ° F (26.7 ° C). Thus, if the battery temperature is considerably lower than or higher than 80 ° F, it will be under-charged or over-charged unless the battery charger has temperature compensation.

TEMPERATURE SENSOR PROBE TF-500

This charger has a provision for temperature compensation. A temperature sensor unit - Model No. TF-500 (16, 17) is provided for this purpose.

CAUTION! This temperature sensor is matched and calibrated for each battery charger and should not be interchanged with the sensor from another battery charger.

The temperature sensor comes with 5 Metre cable. It has a plug (17) on one end. Connect this plug into the jack marked TS (12) on the rear panel of the charger. The other end has the temperature sensor element (16). Mount this temperature sensor element flush with the top surface of the battery for proper heat transfer.

When the temperature sensor is connected, the voltages during Stage 2 and Stage 3 are automatically adjusted as per the temperature of the battery and the above temperature coefficient.

REMOTE PANEL - MODEL NO. 900-RC

An optional wired Remote Panel Model No. 900-RC (15) can be ordered. It comes with 10 metres of flat ribbon cable (14) that has 8 position modular male connector on either end.

The Remote Panel (15) can be used to switch on / switch off the charger and also monitor the charging status of the charger from a remote location.

CONTROLS AND INDICATIONS

The Remote Panel has the following controls / indications:

- Keypad switch for switching on and switching off
- Red LED under “I Phase”
- Yellow LED under “Uo Phase” *
- Green LED under “U Phase”
- Green LED under “Power”

* **Note:** When “Loaded Battery” application is selected (see pages 16 & 17), this will indicate the Float stage (“U” Phase) as in this application, the Boost stage voltage (“Uo” Phase) is the same as the Float stage voltage (“U” Phase).

CONNECTION

To connect the Remote Panel to the charger, insert one connector of the flat ribbon cable (14) into the modular jack on the Remote Panel (15) and the other connector to the modular jack (6) on the charger.

OPERATION

The charger should be first switched on with the help of the AC input power on / off switch (9) located on rear panel of the charger.

The charger can now be switched on and off with the help of the keypad switch on the Remote Panel (15).

INDICATIONS

Whenever the charger is switched on, the Green LED “Power” will be lighted. The other LEDs indicate the charging status as follows:

- Red LED “I Phase” is lighted – Indicates that charger is in Stage 1 - Constant Current, Bulk Charge Mode (“I” Phase) and is delivering 60 A to 48 A (SEC-1260A), 80 A to 64 A (SEC-1280A) or 40 A to 32 A (SEC-2440A)
- Yellow LED “Uo Phase” is lighted – Indicates that the charger is in Stage 2 – Constant Overcharge Voltage, Timed Absorption / Boost Charge Stage (“Uo” Phase) and is delivering between 48 A to 6 A (SEC-1260A), 64 A to 8 A (SEC-1280A) or between 32 A to 4 A (SEC-2440A)
- Green LED “U Phase” is lighted – Indicates that the charger is in Stage 3 - Constant Voltage, Float or Maintenance Charge Mode (“U” Phase). The charger is delivering < 6 A (SEC-1260A), < 8 A (SEC-1280A) or < 4 A (SEC-2440A). The battery is fully charged.

OPERATION

SWITCHING ON / OFF

The charger is switched on /off with the illuminated AC input power on / off switch (9) located on the rear panel of the unit. The switch is illuminated Red when switched on.

INDICATION OF NORMAL OPERATION AND CHARGING STATUS

When the charger is switched on without any load, the Charging Indicator LED (4) on the front panel turns Red, Orange and then Green. The fan (11) will come on momentarily and switch off. If a Remote Panel is connected, its Green LED "Power" will light and the other 3 LEDs will light in sequence - "I" Phase (Red), "Uo" Phase (Yellow) and then "U" Phase (Green).

If a battery or load is connected, the color of the Charging Indicator (4) on the front panel will indicate the charging status as follows:

- **Charging Indicator LED (4) on the front panel is Red** – Indicates that charger is in Stage 1 - Constant Current, Bulk Charge Mode ("I" Phase) and is delivering current as follows:

SEC-1260A:	60 A to 48 A when in Normal Mode 30 A +/- 1A to 24 A when in Half Power Mode
SEC-1280A:	80 A to 64 A when in Normal Mode 40 A +/- 1A to 32 A when in Half Power Mode
SEC-2440A:	40 A to 32 A when in Normal Mode 20 A +/- 1A to 16 A when in Half Power Mode

- **Charging Indicator LED (4) on the front panel is Orange** – Indicates that the charger is in Stage 2 – Constant Overcharge Voltage, Timed Absorption / Boost Charge Stage ("Uo" Phase) and is delivering the following current:

SEC-1260A (Normal Mode)	> than 8.5A +/- 1A and < 48 A (when moving from Float Phase "U" to Boost Phase "Uo") or < 48 A and > 6 A +/- 0.5A (When moving from Boost Phase "Uo" to Float Phase "U")
SEC-1260A (Half Power Mode)	> than 4.25A +/- 1A and < 24 A (when moving from Float Phase "U" to Boost Phase "Uo") or < 24 A and > 3 A +/- 0.5A (When moving from Boost Phase "Uo" to Float Phase "U")
SEC-1280A (Normal Mode)	> than 10A +/- 1A and < 64 A (when moving from Float Phase "U" to Boost Phase "Uo") or < 64 A and > 8 A +/- 0.5A (When moving from Boost Phase "Uo" to Float Phase "U")
SEC-1280A (Half Power Mode)	> than 5A +/- 1A and < 32 A (when moving from Float Phase "U" to Boost Phase "Uo") or < 32 A and > 4 A +/- 0.5A (When moving from Boost Phase "Uo" to Float Phase "U")
SEC-2440A (Normal Mode)	> than 5A +/- 1A and < 32 A (when moving from Float Phase "U" to Boost Phase "Uo") or < 32 A and > 4 A +/- 0.5A (When moving from Boost Phase "Uo" to Float Phase "U")
SEC-1240A (Half Power Mode)	> than 2.5A +/- 1A and < 16 A (when moving from Float Phase "U" to Boost Phase "Uo") or < 16 A and > 2 A +/- 0.5A (When moving from Boost Phase "Uo" to Float Phase "U")

- **Charging Indicator LED (4) on the front panel is Green** – Indicates that the charger is in Stage 3 - Constant Voltage, Float or Maintenance Charge Mode ("U" Phase). The charger is delivering < 8.5 A +/- 0.5 A (SEC-1260A), < 10 A +/- 0.5 A (SEC-1280A) or < 2.5 A +/- 0.5 A (SEC- 2440A). The battery is fully charged. When the battery is fully charged, it will draw very low current to compensate for its self discharge.

CHARGING A BATTERY INSTALLED IN A VEHICLE

Follow these steps when the battery is installed in a vehicle. A spark near a battery may cause battery explosion. For safety and to reduce the risk of spark near the battery:

1. Position AC and DC cords to reduce risk of damage by hood, door or moving engine parts.
2. Stay clear of fan blades, belts, pulleys and other parts that can cause injury to persons.
3. Check the polarity of the battery posts. A Positive (Pos, P, +) battery post usually has a larger diameter than a Negative (Neg, N, -) post.
4. Determine which post of the battery is grounded (connected) to the chassis (engine block). If the Negative post is grounded to the Engine Block (as in most vehicles), see sub paragraph 5. If the Positive post is grounded, see sub paragraph 6.
5. For a Negative grounded vehicle, connect the Positive (Red) DC cable from the charger to the Positive of the battery post. Connect the Negative (Black) DC cable from the charger to a section of heavy gauge metal part of the frame or engine block which is away from battery. Do not connect to carburetor, fuel lines or sheet metal body parts.
6. For a Positive grounded vehicle, connect the Negative (Black) DC cable from the charger to the Negative of the battery post. Connect the Positive (Red) DC cable from the charger to a section of heavy gauge metal part of the frame or engine block which is away from battery. Do not connect to carburetor, fuel lines or sheet metal body parts.
7. Connect the charger AC power cord to the AC outlet.
8. When disconnecting the charger, turn switches to off, disconnect AC power cord, remove connection from the vehicle chassis and then remove connection from the battery terminal.

CHARGING A BATTERY OUTSIDE THE VEHICLE

Follow these steps when the battery is outside the vehicle. A spark near the battery may cause battery explosion. For safety and to reduce risk of spark near the battery, connect the charger as follows:

1. Check the polarity of the battery posts. A Positive (Pos, P, +) battery post usually has a larger diameter than a Negative (Neg, N, -) post.
2. Attach a piece of at least 3" of AWG # 4 insulated battery cable to the Negative battery post.
3. Connect the Positive (Red) DC cable from the charger to the Positive battery post
4. Position yourself and the free end of the piece of cable attached to the Negative post as far away from the battery as possible and then connect the Negative (Black) DC cable from the charger to the free end of the piece of cable attached to the Negative battery post.
5. Do not face the battery when making the final connection.
6. Connect the charger AC power cord to the AC outlet.
7. When disconnecting the charger, always do so in reverse sequence of connecting procedure and break the first connection while standing as far away from the battery as practical.

POWERING OTHER DC LOADS

The charger can be used as a power supply or as a DC UPS (DC Un-interruptible Power Supply). For both these applications, first set switches S1 and S2 of DIP Switch (5) to off position to set the charger to work in 2 stage mode (See under “Selecting the Type of Battery and Charging Stages”).

USING THE CHARGER AS A POWER SUPPLY

To use as a power supply, first switch off the DC load. Connect the DC load between the common negative terminal and one of the 2 positive terminals (either 1 or 2). Ensure that the maximum current drawn by the DC load is below the maximum current rating of the charger. Switch on the charger and then the DC load.

USING THE CHARGER AS A DC UPS

In a DC UPS (Un-interruptible Power Supply) , the charger simultaneously powers the DC load as well as the battery. As long as the AC power to the charger is available and the charger is working normally, the charger will supply the DC load as well as charge / float the battery. In case the AC power fails or if the charger stops working, the battery will automatically power the DC load. As soon as the AC power to the charger is restored, the DC load will once again be fed by the charger and at the same time the battery will be recharged.

CAUTION! Please ensure that the sum of the current drawn by the DC load and the current desired for charging the battery is less than the maximum current capacity of the charger.

To use as a DC UPS, first switch off the DC load and connect it to the battery. Now connect the battery to the charger as explained above under “Charging a Battery outside the Vehicle”.

Switch on the charger and then switch on the DC load.

TROUBLESHOOTING

The symptoms of abnormal operation and the possible cause(s) and remedies are given in the succeeding paragraphs.

There is no output. The AC power on / off switch (9) does not illuminate when switched on. The charging indicator LED (4) is off (On the Remote Panel (15), the Green LED under “Power” is off).

a) There is no AC input voltage in the outlet: Check that AC power is available in the AC outlet receptacle and that it is switched on.

b) The AC input side fuse is blown due to:

- High input voltage - Check that the input voltage is 120 VAC nominal (normal range is 110 to 125 VAC).
- High voltage transients / surges in the AC input line – Ensure that the AC input voltage is clean and does not have high voltage transients / surges. Input voltage surges / transients > 170 VAC (for 120 VAC input) or 340 VAC (for 230 VAC input) will blow the AC side fuse. Use a suitable AC line conditioner / surge suppressor, if necessary.
- The unit has become defective – If fuse is not blowing due to the above two causes, the unit has become defective. Call Technical Support of assistance.

There is no output voltage and the Charging Indicator LED (4) is red (On the Remote Panel (15), the Red LED under “I Phase” is lighted, the Green LED under “Power” is lighted).

a) The DC side output fuse is blown The DC side fuse will blow if the battery is connected in wrong polarity. Ensure that the Positive battery post is connected to the Positive connector of the charger (either Bank 1 or Bank 2) and the Negative battery post is connected to the Negative connector (common) of the charger. Replace the fuse with the fuse with the proper rating.

b) The battery / DC load is shorted. Check and remove the short circuit. The charger will latch in the off condition if it was shut down due to short circuit and will **NOT re-set automatically**. To re-set, switch off the AC power input on / off switch (9) and switch on again.

c) Shut down due to high temperature. Check that the cooling fan is working, the air vents are not clogged and the ambient temperature is not very high. The charger will be latched in this shut down condition and will **NOT reset automatically** even after the unit has cooled down. To reset, the AC input power on / off (9) switch has to be switched off and on again.

When the charger is powered and is being used as a DC power supply / UPS, the output voltage drops when the DC load is switched on or increased.

The charger is being forced into current limit condition. The load is trying to draw current more than the current limit value of the charger – 60 A for Normal operation & 30 A +/- 1 A for “Half Power Mode” for SEC-1260A, 80 A for Normal operation & 40 A +/- 1 A for “Half Power Mode” for SEC-1280A and 40 A for Normal operation & 20 A +/- 1 A for “Half Power Mode” for SEC-2440A (the current limit value is the maximum specified charging Amps). Once the load current reaches the current limit value, the current limit circuit is activated and the output voltage drops. Some loads like motors, compressors, incandescent lamps, halogen lamps, heating elements, relays, coils, capacitors etc. draw very large inrush / starting currents which may reach up to 10 times their normal operating currents. Ensure that the starting / inrush current or the maximum operating current of the load is lower than the current limit value of the charger. Do not use a load that draws more than 60 A (30 A +/- 1 A for “Half Power Mode”) for SEC-1260A, 80 A (40 A +/- 1 A for “Half Power Mode”) for SEC-1280A or more than 40 A (20 A +/- 1 A for “Half Power Mode”) for SEC-2440A. Once the load current is reduced below the above limiting values, the charger will recover automatically.

The battery is getting over charged / overheated / loses water or boils.

a) There is an external load connected to the battery when it is being charged. 3-stage charging is recommended for charging stand-alone or unloaded batteries (there is no load connected to the battery when it is being charged). If a load is also connected simultaneously, a part of the charger’s output current will be diverted to this load. Thus, the charger may remain locked in Stage 2 if the current drawn by the load is more than the preset value of threshold current determining transition from Stage 2 to Stage 3. This will lead to overcharging, overheating and loss of electrolyte.

For charging a battery when a load is also connected simultaneously, Stage 2 voltage should be the same as Stage 3 voltage (Stage 2 is disabled). Select “Loaded Battery” with the help of DIP Switches S1 and S2 of the set of 4 DIP Switches (5) – See under “Selecting the Type of Battery and Charging Stages”.

b) Two banks of batteries are being charged and the batteries in the two banks are in dissimilar state of discharge. When charging more than one bank of batteries at the same time using 3 Stage Charging, ensure that the batteries in the banks are in a similar discharged condition. If one bank is completely discharged and another is almost fully charged, the bank that is fully charged will be subjected to over charge condition during the time when the charger remains in Stage 2 for charging the completely discharged bank.

If 2 banks of batteries are required to be charged and they are at different discharged conditions, select “2 Stage Charging” with the help of switches S1 and S2 of the set of 4 Dip Switches (5) (both S1 & S2 in off condition) – See under “Selecting the Type of Battery and Charging Stages”.

The battery is taking excessively long time to fully recharge

or

When the charger is powered and is being used as a DC power supply / UPS, the output voltage drops at lower DC load currents

The unit is in “Half Power Mode”. (Green LED (8) located on the bottom left corner of the front panel of the unit is lighted). When this mode is selected, the maximum charging current will be automatically reduced to 30 A +/- 1 A for SEC-1260A, 40 A +/- 1 A for SEC-1280A and 20 A +/- 1 A for SEC-2440A. Hence, the charging time will increase. Switch off the “Half Power Mode” if the full rated charging capacity is required.

INTERNAL / EXTERNAL FUSE RATINGS

Both the AC input side and DC output side have fuses.

The AC input side fuse is housed in a fuse holder (10) and is located on the rear panel. It is rated at 250 V, Time Delay (Size 5mm x 20 mm, ceramic tube). Current ratings are as follows:

SEC-1260A:

- For operation from 120 VAC input (pre-set) - 15 A
- For operation from 230 VAC input (will require internal setting) - 8 A

SEC-1280A & SEC-2440A:

- For operation from 120 VAC input (pre-set) - 20 A
- For operation from 230 VAC input (will require internal setting) - 10 A

The DC side fuses are located inside the unit. To access these fuses, remove the bottom cover.

These are automotive blade fuses (for example, “Bussmann” Type ATC) rated as follows:

SEC-1260A	2 pieces in parallel, each rated at 32 V, 35 A
SEC-1280A	3 pieces in parallel, each rated at 32 V, 30 A
SEC-2440A	3 pieces in parallel, each rated at 32 V, 15 A

SPECIFICATIONS

PARAMETER	SEC-1260A
Nominal Input Voltage	
Factory Preset	120 VAC/50-60 Hz (105 to 125 VAC)
By changing internal jumper position	230 VAC/50-60 Hz (207 to 253 VAC)
Input Current	
At 120 VAC input	13.6A
At 230 VAC input	6.8A
Output Voltage, VDC	
Absorption / Boost, "Uo"*	14 V/14.4 V +/-0.05 V
Float / Maintenance, "U"*	13.5 V +/-0.05 V
Maximum Bulk Charging Current, I	
Normal operation	60 A
Half Power Mode	30 A +/-1 A
Threshold of Current for Change Over	
From Float "U" to Boost "Uo"	8.5 A +/-1 A
From Boost "Uo" to Float "U"	6 A +/-0.5 A
Duration for Absorption or Boost Stage, Uo	4 Hours or 8 Hours (Switch selectable)
Temperature Compensation	Yes. With sensor TF-500
Wired Remote Panel (Optional)	Yes. Model 900-RC
Cooling	By fan
Protections	
Overload	Yes
Short Circuit	Yes
Reverse polarity	Yes
Thermal overload	Yes
Output Banks	2
Output Connector	Tubular hole (dia 8 mm) with set screw
Operating Temperature Range	0°C to 40°C
Input Power Cord (Attached)	15A, NEMA5-15 plug
Fuses	
AC Input Side (6 mm x 30 mm; Slow Blow Type)	
For 120 VAC input	15 A / 250 V
For 230 VAC input	8 A / 250 V
DC Output Side (Automotive Blade Type, e.g. Bussmann "ATC")	
In parallel	32 V, 35 A x 2 pcs.
Dimensions (L x W x H), mm	330 x 230 x 108
Weight	4 Kg

Notes: * The charging voltages shown are applicable at battery temperature of 80° F
The above specifications are subject to change without notice

SPECIFICATIONS

PARAMETER	SEC-1280A
Nominal Input Voltage	
Factory Preset	120 VAC/50-60 Hz (105 to 125 VAC)
By changing internal jumper position	230 VAC/50-60 Hz (207 to 253 VAC)
Input Current	
At 120 VAC input	17.2A
At 230 VAC input	8.7A
Output Voltage, VDC	
Absorption / Boost, "Uo"*	14 V/14.4 V +/-0.05 V
Float / Maintenance, "U"*	13.5 V +/-0.05 V
Maximum Bulk Charging Current, I	
Normal operation	80 A
Half Power Mode	40 A +/-1 A
Threshold of Current for Change Over	
From Float "U" to Boost "Uo"	10A +/-1 A
From Boost "Uo" to Float "U"	8 A +/-0.5 A
Duration for Absorption or Boost Stage, Uo	4 Hours or 8 Hours (Switch selectable)
Temperature Compensation	Yes. With sensor TF-500
Wired Remote Panel (Optional)	Yes. Model 900-RC
Cooling	By fan
Protections	
Overload	Yes
Short Circuit	Yes
Reverse polarity	Yes
Thermal overload	Yes
Output Banks	2
Output Connector	Tubular hole (dia 8 mm) with set screw
Operating Temperature Range	0°C to 40°C
Input Power Cord (Attached)	20A, NEMA5-20 plug
Fuses	
AC Input Side (6 mm x 30 mm; Slow Blow Type)	
For 120 VAC input	20 A / 250 V
For 230 VAC input	10 A / 250 V
DC Output Side (Automotive Blade Type, e.g. Bussmann "ATC")	
In parallel	32 V, 30 A x 3 pcs.
Dimensions (L x W x H), mm	382 x 230 x 108
Weight	5.5 Kg

Notes: * The charging voltages shown are applicable at battery temperature of 80° F
The above specifications are subject to change without notice

SPECIFICATIONS

PARAMETER	SEC-2440A
Nominal Input Voltage	
Factory Preset	120 VAC/50-60 Hz (105 to 125 VAC)
By changing internal jumper position	230 VAC/50-60 Hz (207 to 253 VAC)
Input Current	
At 120 VAC input	17.2A
At 230 VAC input	8.7A
Output Voltage, VDC	
Absorption / Boost, "Uo"*	28 V/28.8 V +/-0.05 V
Float / Maintenance, "U"*	27.0 V +/-0.05 V
Maximum Bulk Charging Current, I	
Normal operation	40 A
Half Power Mode	20 A +/-1 A
Threshold of Current for Change Over	
From Float "U" to Boost "Uo"	5A +/-0.5 A
From Boost "Uo" to Float "U"	4 A +/-0.5 A
Duration for Absorption or Boost Stage, Uo	4 Hours or 8 Hours (Switch selectable)
Temperature Compensation	Yes. With sensor TF-500
Wired Remote Panel (Optional)	Yes. Model 900-RC
Cooling	By fan
Protections	
Overload	Yes
Short Circuit	Yes
Reverse polarity	Yes
Thermal overload	Yes
Output Banks	2
Output Connector	Tubular hole (dia 8 mm) with set screw
Operating Temperature Range	0°C to 40°C
Input Power Cord (Attached)	20A, NEMA5-20 plug
Fuses	
AC Input Side (6 mm x 30 mm; Slow Blow Type)	
For 120 VAC input	20 A / 250 V
For 230 VAC input	10 A / 250 V
DC Output Side (Automotive Blade Type, e.g. Bussmann "ATC")	
In parallel	32 V, 15 A x 3 pcs.
Dimensions (L x W x H), mm	382 x 230 x 108
Weight	5.5 Kg

Notes: * The charging voltages shown are applicable at battery temperature of 80° F
The above specifications are subject to change without notice

WARRANTY INFORMATION

2 YEAR Limited Warranty

SEC-1260A / SEC-1280A / SEC-2440A battery chargers manufactured by Samlex America, Inc. (the "Warrantor") are warranted to be free from defects in workmanship and materials under normal use and service. This warranty is in effect for 2 years from the date of purchase by the user (the "Purchaser").

For a warranty claim, the Purchaser should contact the place of purchase to obtain a Return Authorization Number.

The defective part or unit should be returned at the Purchaser's expense to the authorized location. A written statement describing the nature of the defect, the date of purchase, the place of purchase, and the Purchaser's name, address and telephone number should also be included.

If upon the Warrantor's examination, the defect proves to be the result of defective material or workmanship, the equipment will be repaired or replaced at the Warrantor's option without charge, and returned to the Purchaser at the Warrantor's expense.

No refund of the purchase price will be granted to the Purchaser, unless the Warrantor is unable to remedy the defect after having a reasonable number of opportunities to do so.

Warranty service shall be performed only by the Warrantor. Any attempt to remedy the defect by anyone other than the Warrantor shall render this warranty void.

There shall be no warranty for defects or damages caused by faulty installation or hook-up, abuse or misuse of the equipment including exposure to excessive heat, salt or fresh water spray, or water immersion.

No other express warranty is hereby given and there are no warranties which extend beyond those described herein. This warranty is expressly in lieu of any other expressed or implied warranties, including any implied warranty of merchantability, fitness for the ordinary purposes for which such goods are used, or fitness for a particular purpose, or any other obligations on the part of the Warrantor or its employees and representatives.

There shall be no responsibility or liability whatsoever on the part of the Warrantor or its employees and representatives for injury to any persons, or damage to person or persons, or damage to property, or loss of income or profit, or any other consequential or resulting damage which may be claimed to have been incurred through the use or sale of the equipment, including any possible failure of malfunction of the equipment, or part thereof.

The Warrantor assumes no liability for incidental or consequential damages of any kind.



samlexpower

110-17 Fawcett Rd
Coquitlam, B.C.
Canada V3K 6V2

T: 604 525 3836
F: 604 525 5221

e-mail: samlex@samlexamerica.com
website: www.samlexamerica.com



Samlex America Inc.
110-17 Fawcett Road
Coquitlam B.C., Canada V3K 6V2
e-mail: samlex@samlexamerica.com
website: www.samlexamerica.com